

Round container 120ml/ 75mm sealing

Product code: 00035220







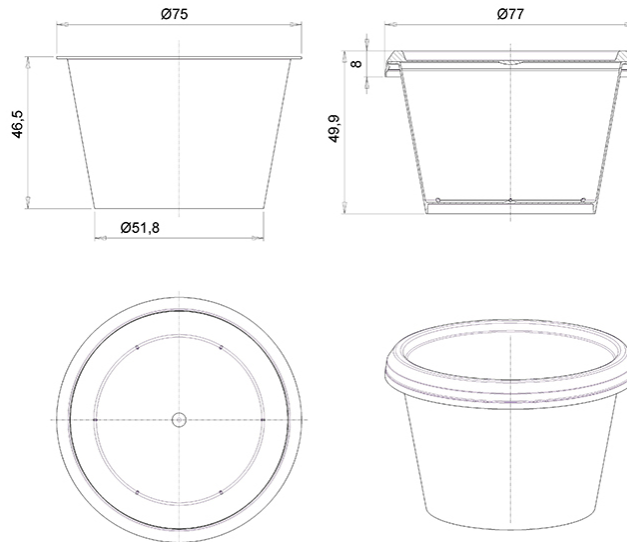

| | |
|-------------------|--------------|
| Volume, ml | 120 |
| Lid size, mm | 75 |
| Height, mm | 46,5 |
| Base shape | Round |
| Side wall shape | Straight |
| Types of closures | Heat Sealing |
| Types of lids | Snap-on lid |
| IML on body | - |
| IML on the lid | Yes |









| Minimum order quantity | Body | Lid | Set |
|-------------------------------|-------------|-------------|-------|
| Pieces per box | 760 | 1 520 | 1 520 |
| Logistics | Body | Lid | Set |
| Pieces per box | 760 | 1 520 | 1 520 |
| Box size (mm) | 600x400x145 | 600x400x145 | - |
| Box weight with product (kg) | 4,8 | 3,8 | 13,3 |
| Volume (m3) | 0,041 | 0,041 | 0,123 |
| Quantity of boxes (pcs) | 2 | 1 | 3 |
| Quantity in pallet (pcs) | 39 520 | 79 040 | - |
| Pallet weight with goods (kg) | 269 | 217 | - |
| Pallet height with goods (m) | 2,04 | 2,04 | - |



-  Fish processing
-  Dairy products
-  Confectionery

-  HoReCa
-  Fats & Oils
-  Cooking

-  Laquers & Paints
-  Pet food
-  Cosmetics

-  Fasteners
-  Fishing gear
-  Household chemicals

